

Artemide®

Tolomeo Pinza - Tolomeo Micro Pinza

design
M. De Lucchi
G. Fassina

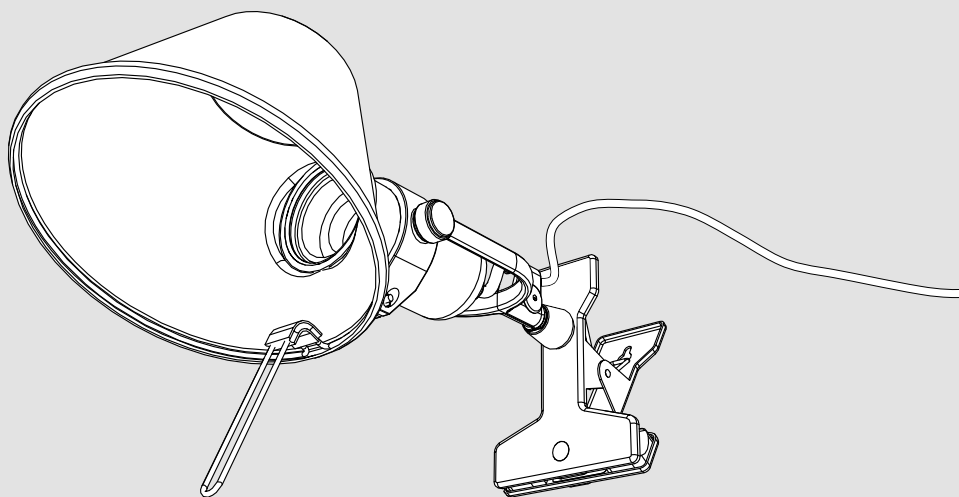



i

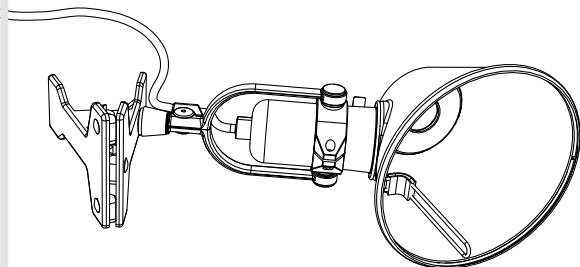
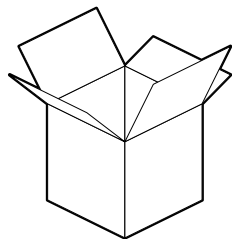
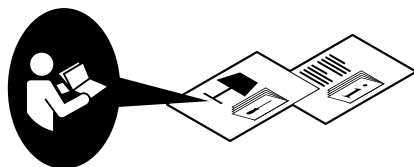

1

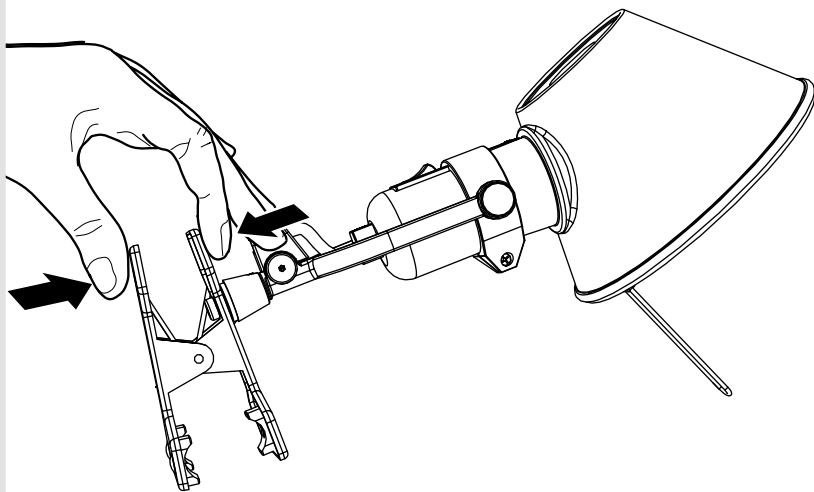

2

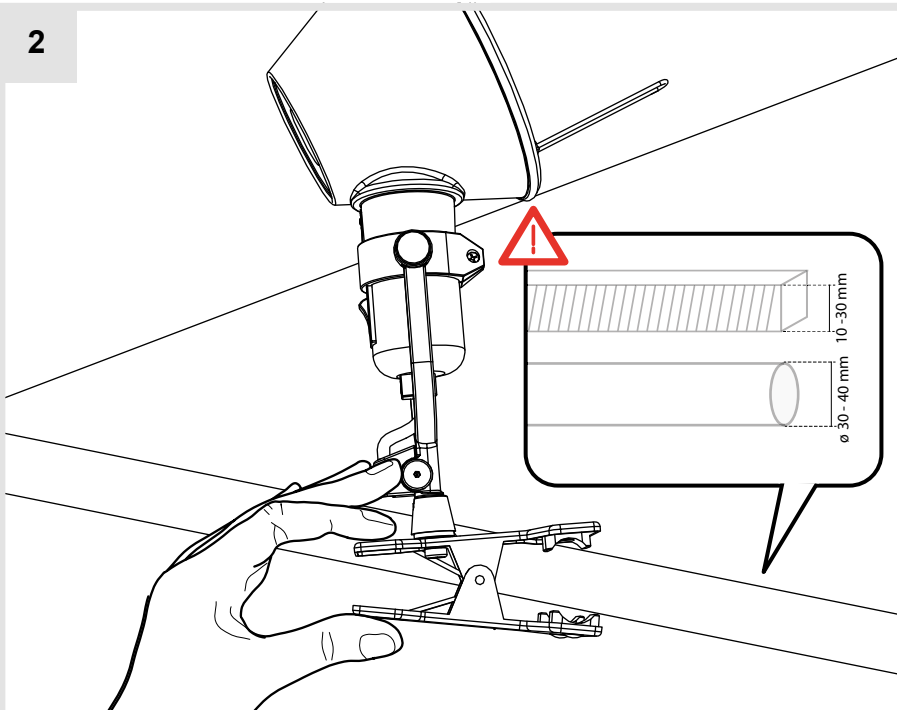

3

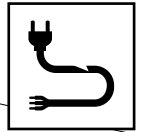
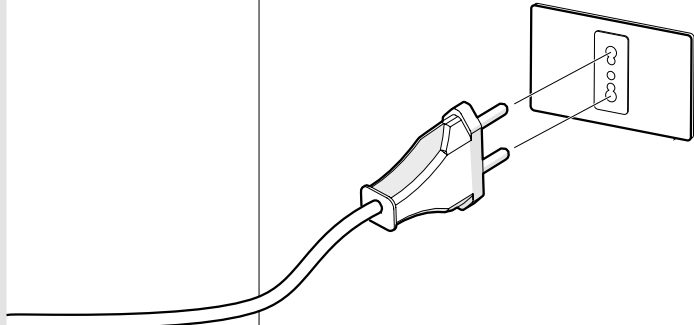

 A0058...

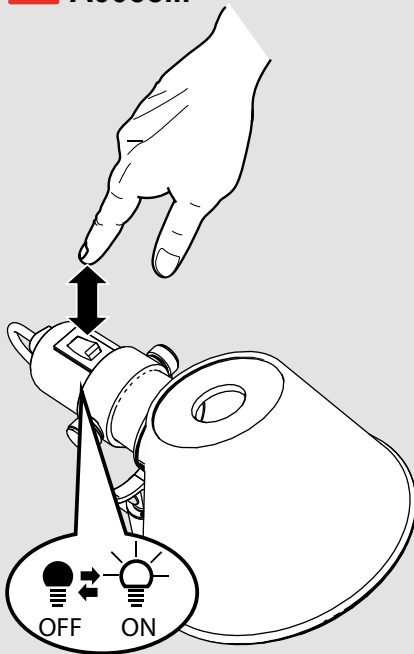

 A0108...

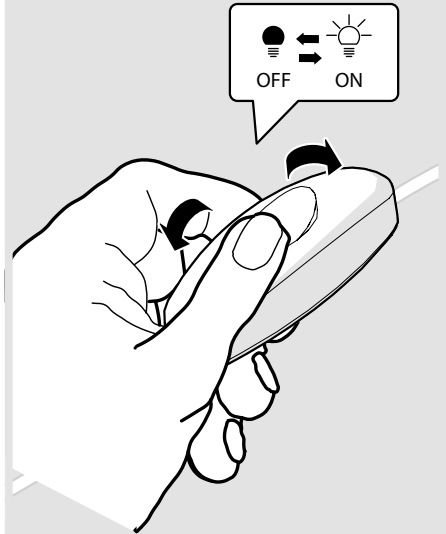



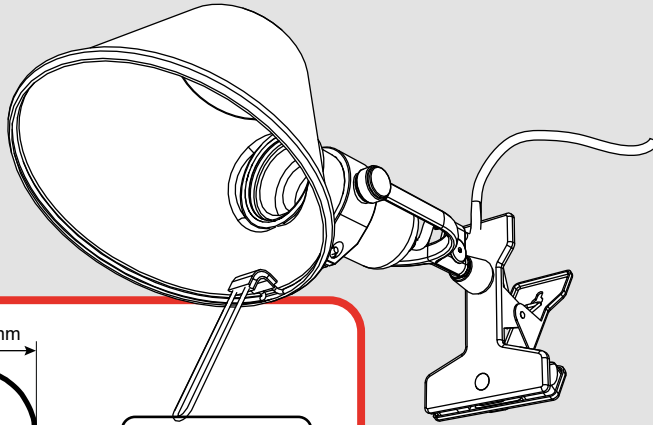

i

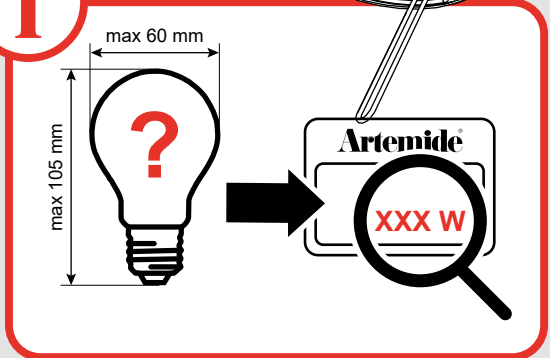

i



 A0058...

i

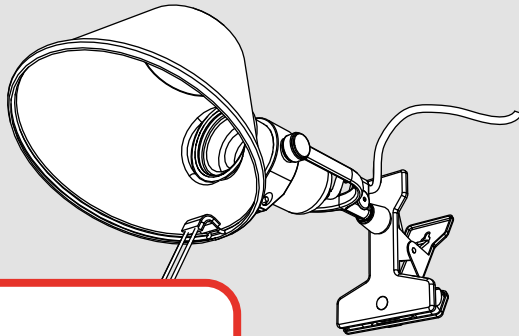

i

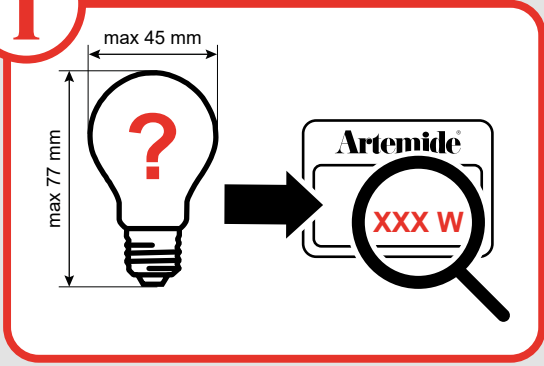

 A0108...

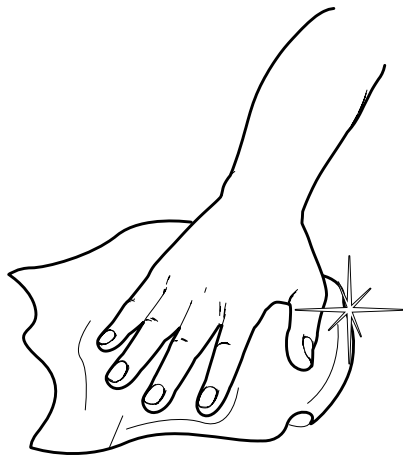
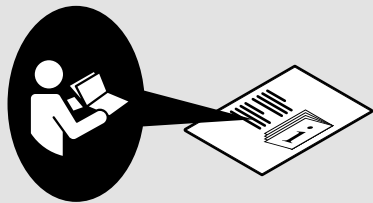

Artemide®

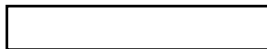

Artemide

via Bergamo, 18
20006 Pregnana M.se (MI)
ITALIA

tel. +39 02 935 181
fax +39 02 935 90 254
fax +39 02 935 90 496

www.artemide.com

VAT IT00846890150

cod. Y513000580B